

Product datasheet



Wireless communication

Heating pads

GreenLINE

GreenLINE series

KT-LFP12280-GL

LiFePO₄ battery

lithium-iron-phosphate

Equipped with heating pads and wireless communication.

12.8 V | 280 Ah

TECHNICAL PARAMETERS

PARAMETERS

Rated voltage	13.2 V ± 0.1 V (C/20)
Nominal voltage	12.8 V
Nominal capacity	280 Ah
Nominal energy	3584 Wh
100% DoD lifespan	2500 cycles
80% DoD lifespan	3500 cycles
60% DoD lifespan	4500 cycles
Capacity reduction	30% after 2500 cycles @100% DoD
Expected chemical durability	Up to 12 years
Efficiency	97%

CHARGE AND DISCHARGE

Recommended charging voltage rate	14 ~ 14.2 V
Maximum charge current	200 A
Recommended charge current	56 A
BMS charge cut-off voltage	14.7 V
Balancing voltage	14 V (3.5 V per cell)
Charge method	CC / CV
Charge time	10 A – 28 h / 20 A – 14 h
Maximum continuous discharge current	200 A
Maximum temporary discharge current	220 A (5 s)
Recommended low voltage cut-off	11 V
Minimum BMS cut-off voltage	10 V
Reconnect voltage	12 V

OPERATING CONDITIONS

Heating pads	Yes
Operating temperature	From -20°C to 60°C
Charging temperature	From -20°C to 45°C
Storage temperature	From -20°C to 45°C
BMS cut-off temperature	65°C (charging)
Reconnect temperature	75°C (discharging)

OTHER

Weight	26.6 kg
Dimensions (without terminals)	528 × 274 × 229 mm
Terminals height	~25 mm
Terminal type	M8
Terminal torque tightening	8 - 10 Nm

COMMUNICATION

Wireless communication	Yes
------------------------	-----

COMPATIBILITY

Certificates	CE, UN38.3
--------------	------------

Battery is equipped with built-in Battery Management System (BMS).

PROTECTION

Charging at too low temperatures, overcharging, overdischarging, short circuit, high temperatures, passive cell balance.

DIMENSIONS

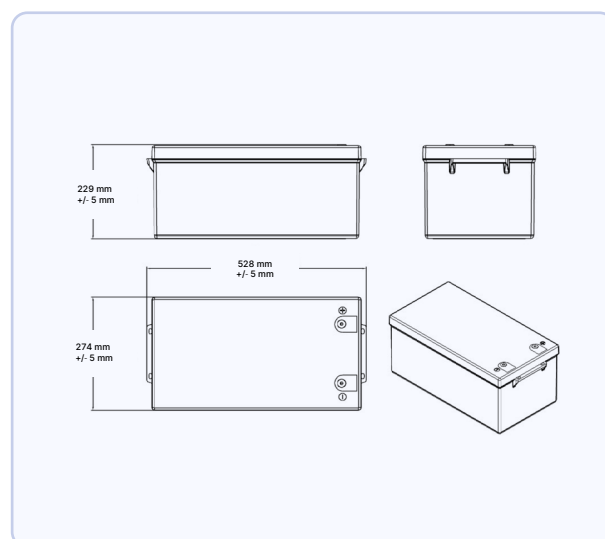

FEATURES

Heating pads

Kon-TEC batteries are capable of charging even at low temperatures (below 0°C).

Wireless communication

Wireless communication integrated with the BMS system ensures communication between the battery and the mobile device and allows for real-time reading of battery parameters.

Lightness

Kon-TEC batteries are 50% lighter (or more) than conventional lead-acid, gel, or AGM batteries. They also provide greater power delivery.

Fast charging with low energy loss

High energy efficiency is ensured by a very high performance level (around 97%).

Exceptional power

100% current regardless of the degree of discharge. For lead-acid batteries, this means no more than 60% of the declared capacity.

Very high lifespan

2500 cycles at 100% DoD (full charge and discharge), up to 4500 or more cycles at 60% DoD. By comparison, a lead-acid battery typically only lasts about 200-300 cycles.

Efficiency gain

The LiFePO₄ battery has a two times lower cost of released energy compared to GEL batteries.

APPLIANCE

LiFePO₄ batteries have a wide range of applications. As reliable energy storage devices, they can be used for power supply of electrical devices, vehicles, or systems from almost any industry.

They can be used in the following cases:

- > Replacement for SLA batteries (lead-acid and gel).
- > Caravans and motorhomes.
- > Specialised electric vehicles.
- > Electric motors.
- > Yachts, catamarans, houseboats.
- > Wheelchairs and vehicles for the disabled.
- > Hybrid photovoltaic systems.
- > Wind turbines.
- > Emergency lighting.
- > 12 V devices and toys.
- > Power source for 12 V~ / 230 V~ inverters.

BATTERY LIFESPAN IN CYCLIC OPERATION

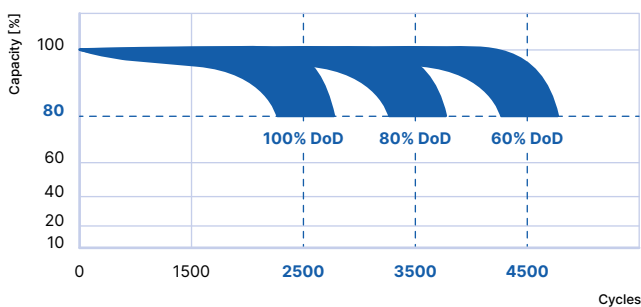

GENERAL PRECAUTIONS

- Do not expose the battery to UV radiation
- Do not immerse the battery in water.
- Do not leave the battery nearby heat sources.
- Charge the battery only under supervision.
- Do not short-circuit the + and – poles with any conductive elements
- Do not connect the battery directly to electrical sockets.
- Do not throw the battery into fire.
- Do not transport the battery together with other metal objects.
- Do not hit, throw or trample on the battery.
- Do not puncture the battery with any objects.
- Do not disassemble/open the battery.
- Do not store an unused battery for a long time.
- Do not leave the battery outdoors at high temperature.
- Do not use the battery in a strong electrostatic area or magnetic field.
- Read the manual of the charger carefully.
- Store the battery with protected terminals.
- Keep the battery away from children and animals.
- Do not wear metal objects during handling and use of the battery.
- Charging time should not be longer than in the charger manual.
- Do not solder anything to the battery.
- Do not expose the battery to microwaves and high air pressure.
- Do not apply any form of pressure to the battery.
- If the battery emits a strange smell, it is noticeably hot, changes color and deforms, differs or deviates in any other way from the norm when using, disconnect immediately remove the load and move it to a safe place, then contact with the supplier/manufacturer.
- If the battery terminals are dirty, clean them with a dry cloth, otherwise the connection to the battery may be defective.

STORAGE AND LIFESPAN

Batteries should be stored under the following conditions:

- Avoiding direct exposure to sunlight in ventilated rooms
- For long-term storage this should be done in rooms with low humidity and temperature ranging from -10°C to +45°C.
- Store the battery fully charged.
- When storing the battery for 6 months or LONGER, at least one full cycle is required battery discharge and charge to avoid destruction of cells through self-discharge.

Number of cycles (lifespan) after which the battery retains its at least 80% of the nominal capacity, depends on depth of discharge. Cycle number is no less than 2500 when discharged in 100% DoD cycles (full charge and discharge).

After exceeding 2500 cycles, the battery is still functional, and its capacity is at least 80% of the nominal capacity and begins to decrease with time and/or continued use. The shallower the discharge cycles, the longer the life. Accordingly, for 80% DoD cycles (discharging to 20% of the total capacity), the service life is 3500 cycles and for 60% DoD cycles (discharging to 40% of total capacity), service life is 4500 cycles.

The estimated life of the battery electrolyte is taken as approximately 12 years of use.

ATTENTION

Due to the non-linear nature of LiFePO₄ battery discharge, its voltage ranges remain almost constant value, in a wide range of its capacity (Fig. 9). Nominal voltage of 12.8 V (for our batteries), may mean either a charged battery at approximately 90% of the rated capacity, BUT also discharged to close to 0% of the rated capacity. As you can see on the characteristics, the battery whose resting voltage (open circuit, no load) is 12.8 V (or less), can be fully discharged. Therefore, in the case of LiFePO₄ batteries, this is not allowed to suggest by their voltage in order to determine their actual value discharge / charge level.

You should never allow a situation in which the resting voltage on the LiFePO₄ battery terminals is less than 12.8 V.

Fig. 9. Battery voltage drop, 1C discharge

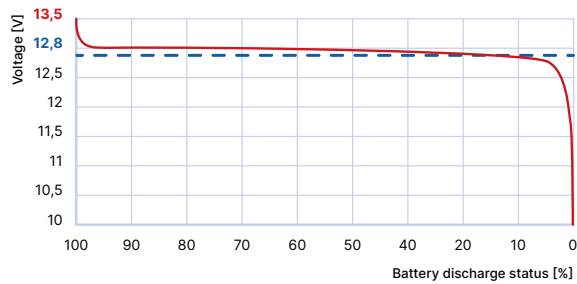
**WARUNKI GWARANCJI**

The above product, which is a 12.8 V LFP battery, is covered by: guarantee to the customer that this product will be free from defects materials and production for a period of 5 years from the production date, or 3 years from the date of purchase (no more than 5 years from the date of production) in Poland. If symptoms occur during the warranty period that may indicate a product defect, please contact our technical support who will advise you on how to proceed warranty procedure. Defective product covered under this warranty will be restored to operational condition or replaced if a fault makes it impossible to repair. Consideration warranty will take place within no longer than 30 business days from the date of receipt of the complaint. Device replacement includes the delivery of a new, defect-free product the same or - in the event that it is withdrawn from production with similar parameters, excluding dimensions that may change. There may appear repair traces on the outer packaging of the battery after service activities.

This warranty does not apply:

- > in case of incorrect connection or use or charging the device,
- > if the product has been modified, opened, altered or damaged as a result of inappropriate use,
- > if you do not follow the instructions for use of the device,
- > if the product is sold at a public auction,
- > if the device is damaged in an accident or natural disaster,
- > in case of destruction of terminals/terminals connection lines,
- > if the device is destroyed by fire, freezing or high temperature,
- > in case of flooding/crushing due to pressure,
- > in case of user interference with the device,
- > in case of damage to the battery case.

Kon-TEC Sp. z o.o.



ul. Boya-Żeleńskiego 12, Building B
35-105 Rzeszów



Levne-Baterky.cz



Bavorská 856, Areál Mototechna
Stodůlky, 155 00 Praha 5
+420 771-149-917
obchod@levne-baterky.cz
www.levne-baterky.cz